



T&S BRASS AND BRONZE WORKS, INC.

2 Saddleback Cove / P.O. Box 1088
Travelers Rest, SC 29690

Model No.

EC-1210-08

Item No.

Travelers Rest, SC: 800-476-4103 • Simi Valley, CA: 800-423-0150 • Fax: 864-834-3518 • www.tsbrass.com



This Space for Architect/Engineer Approval

Job Name _____ Date _____

Model Specified _____ Quantity _____

Customer/Wholesaler _____

Contractor _____

Architect/Engineer _____

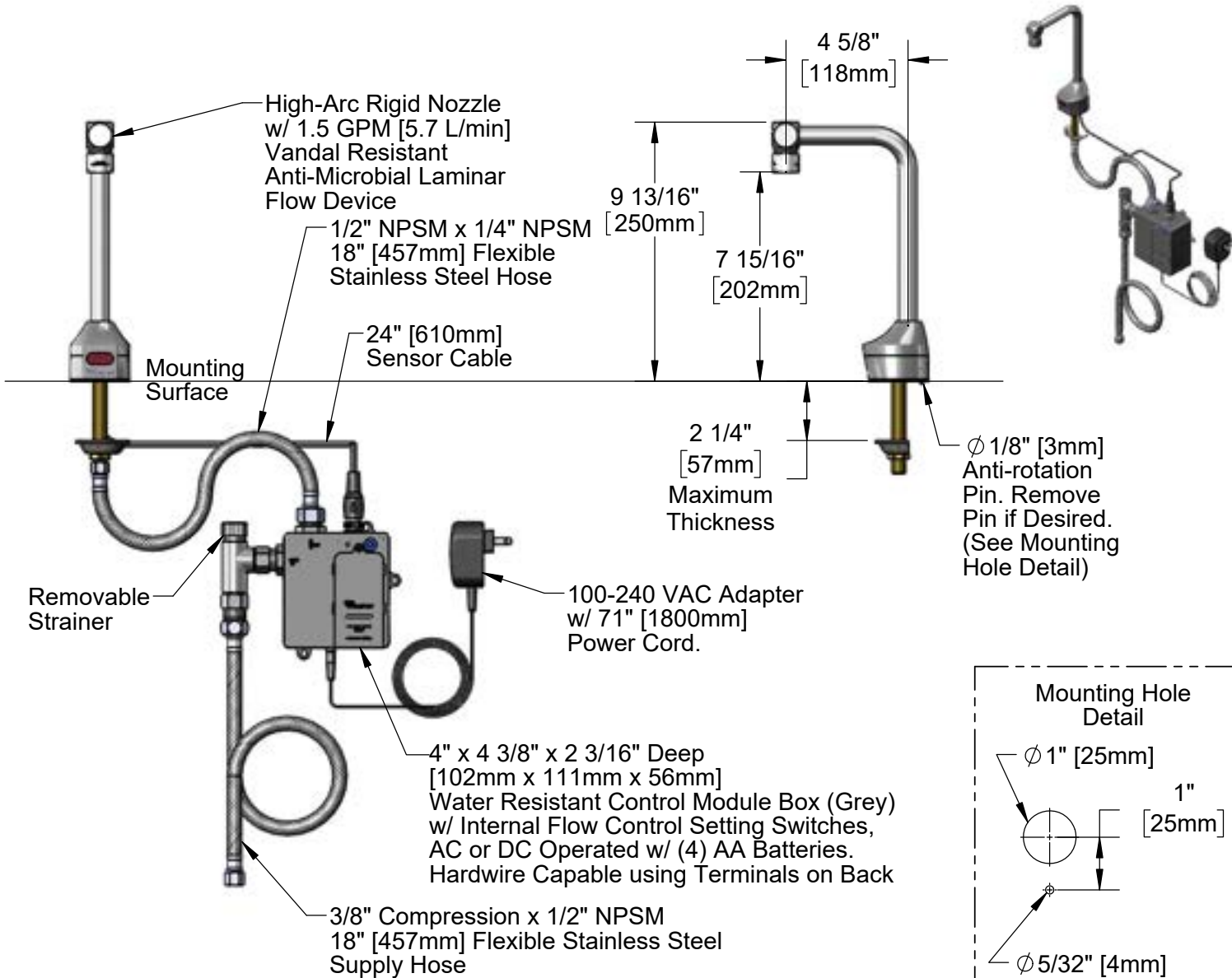
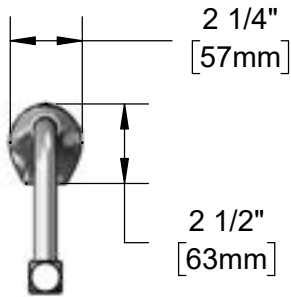

Product Specifications:

8" High Chrome Plated Brass Electronic Glass Filler: Single Hole Deck Mount, High-Arc Rigid Nozzle w/ VR 1.5 GPM Anti-Microbial Laminar Flow Device, AC/DC Control Module w/ Internal Flow Control Setting Switches, and 18" Flexible Supply Hose

Product Compliance:

ASME A112.18.1 / CSA B125.1
NSF 61 - Section 9
NSF 372 (Low Lead Content)
ANSI A117.1 (ADA)
UL 1951



T&S BRASS AND BRONZE WORKS, INC.

2 Saddleback Cove / P.O. Box 1088
Travelers Rest, SC 29690

Model No.

EC-1210-08

Item No.

Travelers Rest, SC: 800-476-4103 • Simi Valley, CA: 800-423-0150 • Fax: 864-834-3518 • www.tsbrass.com

ITEM NO.	SALES NO.	DESCRIPTION
1	B-0199-06-LF15A	VR 1.5 GPM Laminar Flow Device (Anti-Microbial) w/ VR Key
2	015425-45	Vandal Resistant Key
3	019174-45	Sensor Cable Assembly
4	016297-45	Inlet Hose, Faucet, 1/2" NPSM-F x 1/4" NPSM-F
5	019944-45	ChekPoint Control Module w/ Filter Tee
6	5EF-0002C	AC Adapter - US Plug
7	5EF-0005	Supply Hose, 9/16-24 Female x 1/2" NPSM
8	002534-25	Close Nipple, 1/2" NPT
9	EC-FILTER	Replacement Filter

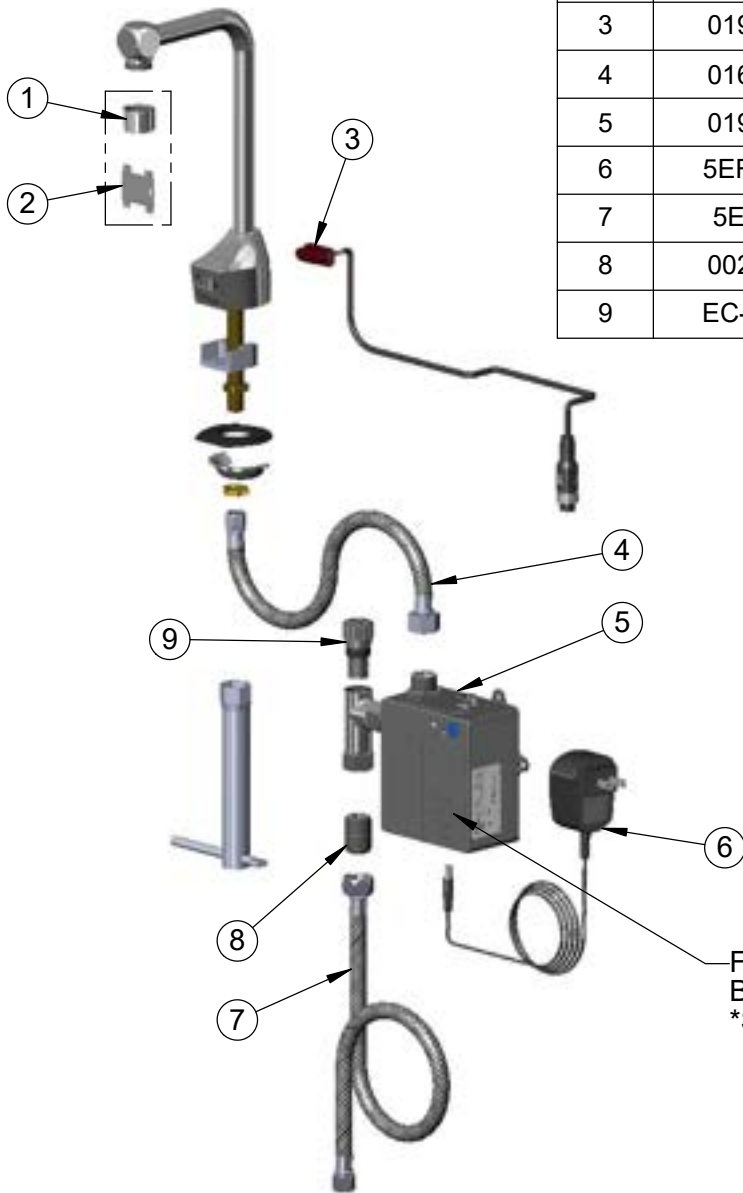

A Maximum of (8) ChekPoint Faucets can be Hardwire Connected and Powered by EC-HARDWIRE ChekPoint Hardwire AC Transformer. (Sold Separately)

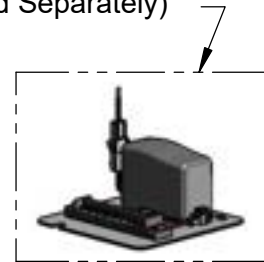

Flow Control Switches are Located Behind Battery Compartment Cover
*Switches are Set to DEFAULT Position:
- Auto Time Out = 15 Seconds
- Shut Off Delay = 1 Second
- Auto Flush = OFF
- Metering Mode = OFF

***Available Water Flow Control Selections:**

- Auto Time Out: 15 sec, 30 sec, 45 sec, 60 sec, 3 min, 20 min
- Shut Off Delay: 1 sec, 10 sec, 15 sec, 30 sec
- Auto Flush (30 Seconds After Every 12 Inactive Hours): ON or OFF
- Metering Mode: ON or OFF

Product Specifications:

8" High Chrome Plated Brass Electronic Glass Filler: Single Hole Deck Mount, High-Arc Rigid Nozzle w/ VR 1.5 GPM Anti-Microbial Laminar Flow Device, AC/DC Control Module w/ Internal Flow Control Setting Switches, and 18" Flexible Supply Hose

Product Compliance:

ASME A112.18.1 / CSA B125.1
NSF 61 - Section 9
NSF 372 (Low Lead Content)
ANSI A117.1 (ADA)
UL 1951