

# The E-Tronic® 80

## Contemporary design with Dependable touchless convenience.

The E-Tronic® 80 offers a new, contemporary design option for commercial restroom applications. With above-deck electronics, including models with integrated scald protection\*\*, the E-Tronic 80 eliminates clutter below the deck to enhance the overall design of the room.



### Saves Water

Adjustable run time with vandal resistant outlet options from .35 to 1.5 GPM.

### Easy to Install and Service

Electronic components are above-deck for faster installation and easier maintenance.

### Added Safety

Available with an integral ASSE 1070 compliant thermostatic protection\*\* to help prevent scalding.

Optional **Commander™ handheld programming unit** maintains and monitors your faucets.

- Five Running Modes
- Hygiene Flush
- Track Usage



### Versatile Design

Available with single or dual supply. Dual supply features user adjustable temperature control. Installers can easily convert to concealed control with included vandal resistant chrome plated cap.

## Innovative Power Options

### LTPS

**Long Term Power System**  
Maintenance-free power for 15 years or more.

### AC

**Plug-In or Hard-Wire**

### DC

**Lithium CRP2 Battery**



### Dual Supply

Comes with external temp control or convert to concealed mixer. Available with optional thermostatic protection.



### Single Supply

Connects easily to a building's pre-tempered water supply or an external mixing valve.

## Accessories



4" Cover Plate  
3500-001KJKCP



8" Cover Plate  
3500-002KJKCP



Commander™  
Handheld Unit  
116.585.00.1

## Codes & Standards

ASSE 1070 Certified\* | Certified to NSF/ANSI 61, Section 9

ASME A112.18.1/CSA B125.1 Certified



Complies with ADA requirements as specified in the Americans with Disabilities Act.

\*Only models with thermostatic mixer are ASSE 1070 certified.

\*\*Patent pending.

# Touchless Faucets

## E80-A11A-11ABCP

### Product Type

---

Advanced electronic commercial faucet with touchless sensor operation

### Features & Specifications

---

- Compatible with Commander™ Handheld Programming Unit; multiple field-adjustable modes and ranges
- Single hole
- Vandal Proof Pressure compensating Econo-Flo™ non-aerating spray outlet 0.5 GPM
- ECAST® design provides durable cast brass construction with total lead content equal to or less than 0.25% by weighted average
- Complies with the requirements of the Buy American Act of 1933.

### Performance Specification

---

- Rated Operating Pressure: Operating static pressure: 20-125 PSI (138-862 kPa). Mixed water temperature range: up to 180°F (82°C). **WARNING!** Water temperatures in excess of 110°F (43°C) are dangerous and may cause scalding, severe injury or death! This fitting is NOT factory preset and can deliver water at temperatures exceeding 110°F (43°C).





### Warranty

---

- 3-Year Limited Electronics and Solenoid Warranty
- Lifetime Limited Faucet Warranty
- 1-Year Limited Finish Warranty
- 5-Year Limited Mechanical Warranty

### Codes & Standards

---

-  ASME A112.18.1/CSA B125.1
-  ADA ANSI/ICC A117.1
-  NSF/ANSI 372 Low Lead Content
-  NSF/ANSI 61, Section 9

Job Name \_\_\_\_\_

Item Number \_\_\_\_\_

Section/Tag \_\_\_\_\_

Model Specified \_\_\_\_\_

Architect \_\_\_\_\_

Engineer \_\_\_\_\_

Contractor \_\_\_\_\_

Submitted as Shown       Submitted with Variations

Date \_\_\_\_\_



### ECAST

ECAST products are intended for installation where state laws and local codes mandate lead content levels or in any location where lead content is a concern.

2100 South Clearwater Drive  
Des Plaines, IL  
P: 847/803-5000  
F: 847/803-5454  
Technical: 800/TEC-TRUE  
www.chicagofaucets.com

## Architect/Engineer Specification

Chicago Faucets No. E80-A11A-11ABCP, E-Tronic 80 electronic faucet with dual-beam infrared sensor. Integral spout, chrome plated. Single-hole deck mount. 0.5 GPM (1.9 L/min) vandal-proof, pressure compensating, Econo-Flo, non-aerating spray. Single supply for tempered water. 6 Volt Lithium CRP2 Battery (Included). Flexible supply hose included. Multiple field-adjustable modes and ranges. Compatible with Chicago Faucets Commander™ handheld programming unit. ECAST® construction with less than 0.25% lead content by weighted average. CALGreen compliant. This product meets ADA ANSI/ICC A117.1 requirements and is tested and certified to industry standards: ASME A112.18.1/CSA B125.1, Certified to NSF/ANSI 61, Section 9, California Health and Safety Code 116875 (AB1953-2006), Vermont Bill S.152, NSF/ANSI 372 Low Lead Content, and California Green Building Standards Code (CALGreen).

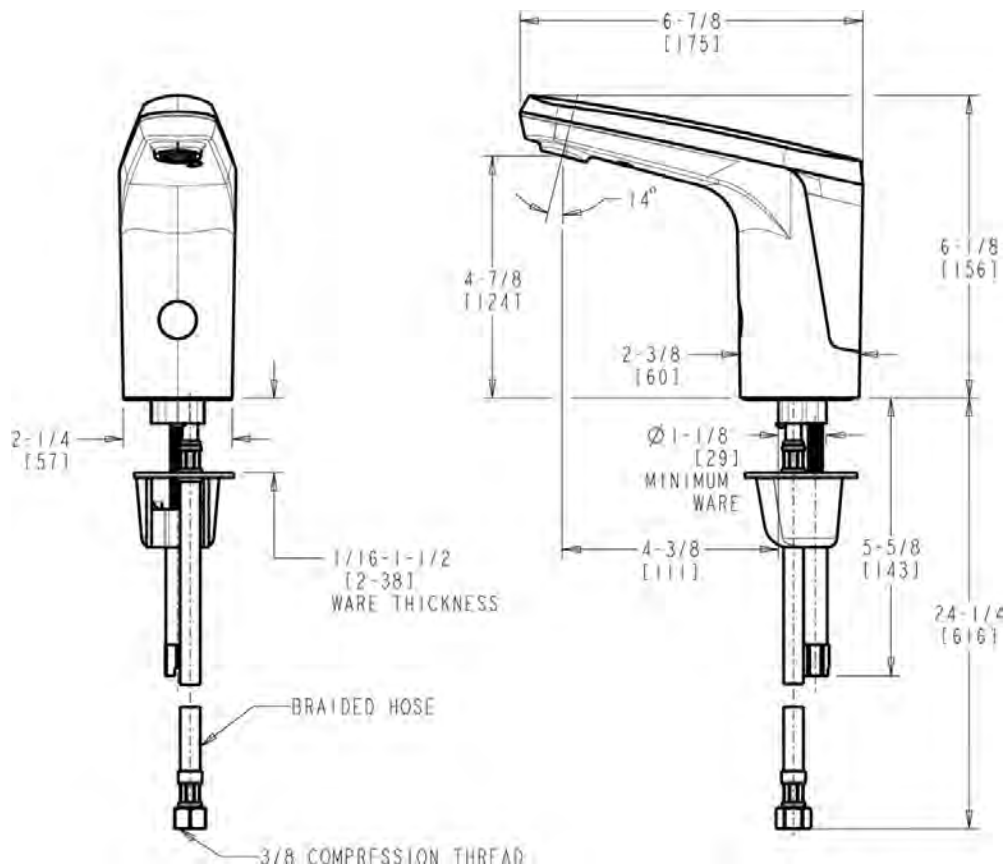

## Operation and Maintenance

Installation should be in accordance with local plumbing codes. Flush all pipes thoroughly before installation. After installation, remove spout outlet or flow control and flush faucet thoroughly to clear any debris. Care should be taken when cleaning the product. Do not use abrasive cleaners, chemicals or solvents as they can result in surface damage. Use mild soap and warm water for cleaning and protecting the life of Chicago Faucet products. For specific operation and maintenance refer to the installation instructions and repair parts documents that are located at [www.chicagofaucets.com](http://www.chicagofaucets.com).

Chicago Faucets, member of the Geberit Group, is the leading brand of commercial faucets and fittings in the United States, offering a complete range of products for schools, laboratories, hospitals, office buildings, food service, airports and sport facilities. Call 1.800.TECTRUE or 1.847.803.5000 Option 1 for installation or other technical assistance.



# Repair Parts

E80-A11A-11ABCP

Advanced electronic commercial faucet with touchless sensor operation

# CHICAGO FAUCETS

Geberit Group

E-Tronic 80 Single Supply Base

## Base Parts:

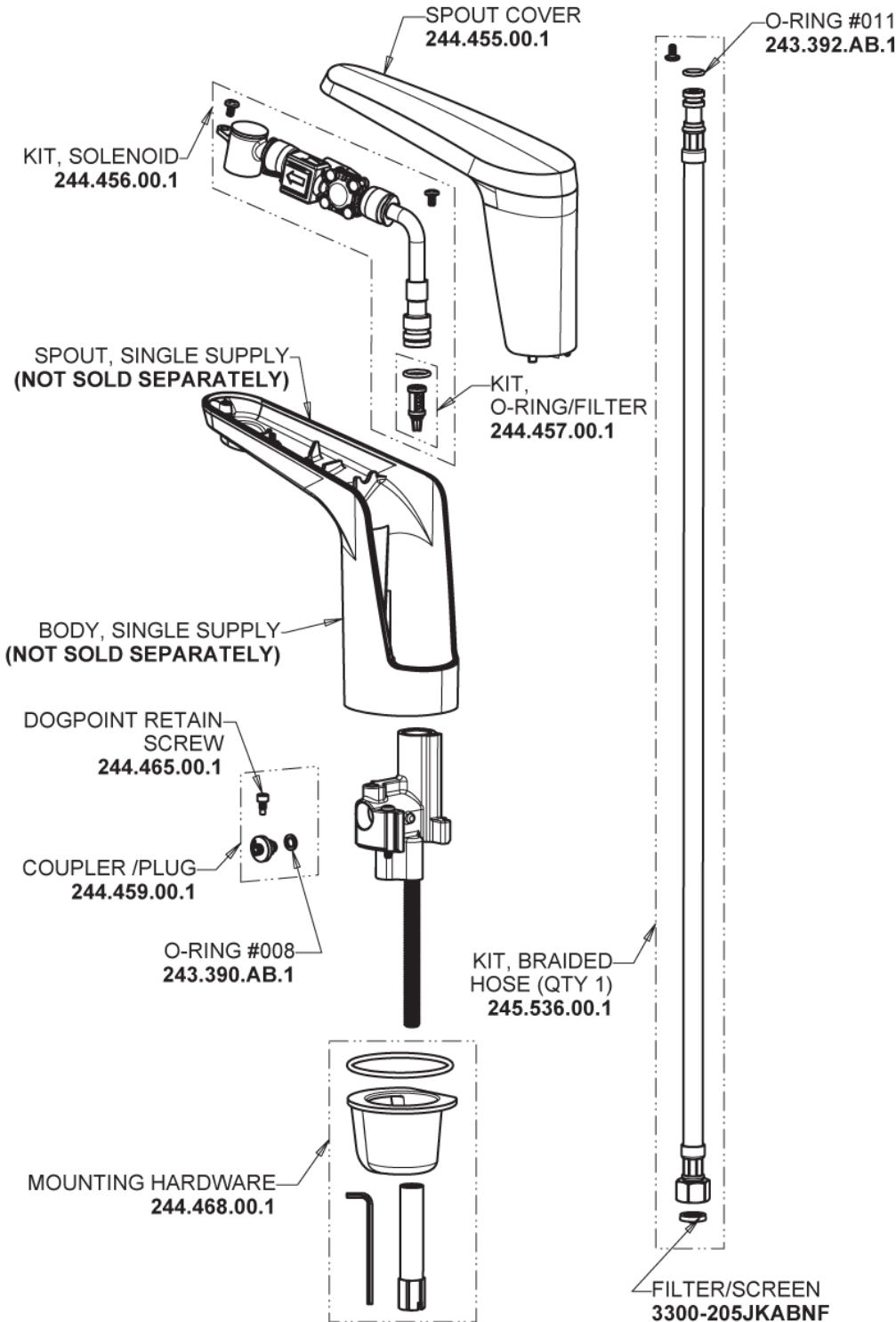

0.5 GPM (1.9 L/min) Vandal Proof Pressure Compensating Econo-Flo Non-Aerating Spray Outlet  
243.145.AB.1



Electronic Module  
244.458.00.1

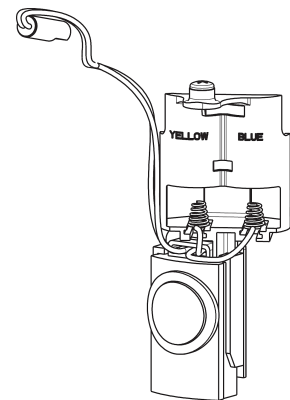

CR-P2 6V Lithium Battery  
242.560.00.1

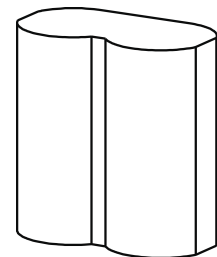

## For Technical Assistance:

Phone: 800-TEC-TRUE (832-8783)

Email: [techsupport.us@chicagofaucets.com](mailto:techsupport.us@chicagofaucets.com)

2100 South Clearwater Drive

Des Plaines, IL 60018

Phone: 847-803-5000

[chicagofaucets.com](http://chicagofaucets.com)